

MC-V09-201-S

**Made in
USA**



- Durable Stainless Steel 304 Diaphragm
- Epoxy Encapsulated Electronics
- UL Approved
- NEMA 4X Certified with Optional Gasket
- Reliable Piezoelectric Technology

OUTPUT SOUND and CURRENT CONSUMPTION vs. INPUT VOLTAGE PERFORMANCE.

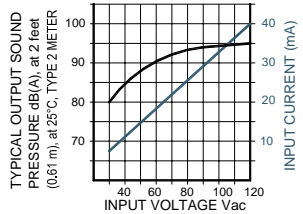

The MC-V09-201-S is a continuous tone, panel mounted alarm for operating voltages of 30-120VAC. The built-in volume control provides variable attenuation up to 20 dB(A) typically.

SPECIFICATIONS

Operating Mode:	Medium Loud Continuous Tone
Operating Voltage:	30-120 Vac
Nominal Operating Voltage:	110 Vac
Operating Frequency:	2900±250 Hz.
Typical Operating Current:	7 mA at 30 Vac 40 mA at 120 Vac
Typical Sound Pressure:	With volume control fully open: 80±5 dB(A), at 30 Vac, at 24 inches (61 cm), at 25°C 95±5 dB(A), at 120 Vac, at 24 inches (61 cm), at 25°C.
Termination:	0.25 (6.3) Wide Quick Connect Blades with 0.25 (6.3) Long 6x32 Stainless Steel Screws
Termination Strength:	Pull test with a maximum of 22 pounds (10 kg) load
Operating Temperature:	-20°C to +65°C.
Storage Temperature:	-40°C to +85°C.
Surge Voltage:	20% over maximum rated voltage for less than 5 minutes.
Part Recognized By:	Underwriters Laboratory
Construction Materials:	Case- Plastic "NORYL® N-190", Flame Retardant UL 94-VO, Black Internal Circuit- Audio-oscillator and piezoelectric driver Potting- 2 parts epoxy resin or silicone, black Diaphragm- Stainless Steel 304 Gasket (Sold Separately)— 0.062" Thick, 60 Durometer Neoprene
Environmental Durability:	Salt Spray- Withstand exposure to salt spray per ASTM B117 for a period of 300 hours with no decrease in sound output Humidity- 95% relative humidity at +40°C continuously for 100 hours. Vibration- Withstands vibration between 0 and 55 Hz. on all axes.
Life Expectancy:	10 years under normal operating conditions.
Warranty:	For a period of two years from the date of manufacture under normal operating conditions.

RoHS Also available RoHS Compliant — Add "R" to end of part number.

DIMENSIONS

REAR VIEW
STAINLESS STEEL SCREWS,
6 X 32, 0.25" LONG.

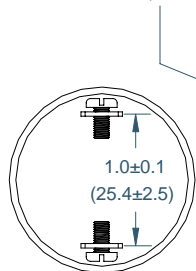

SIDE VIEW

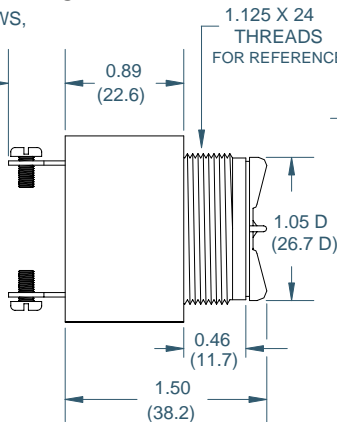

RING

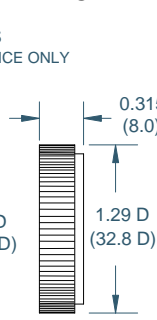

FRONT VIEW

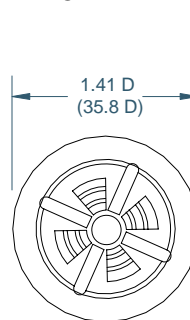

DIMENSIONS ARE IN: INCHES (mm)
TOLERANCES ARE: ±0.03 (±0.76)
UNLESS OTHERWISE SPECIFIED.

PANEL MOUNTING

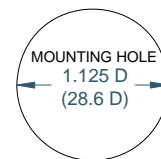

FITS PANELS UP-TO
0.25 (6.3) THICK

"S" TERMINALS

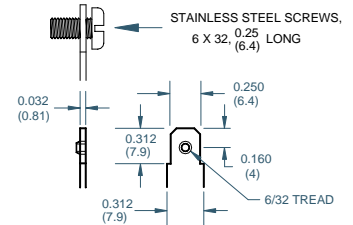

Floyd Bell Inc
An ISO 9001:2000 Registered Company

720 Dearborn Park Lane • Columbus, OH 43085
Tel: 888-FLOYD-BELL • Fax: 614/291-0823
www.floydbell.com

Revision: 2.07