

# MC-V09-530-Q

**Made in  
USA**

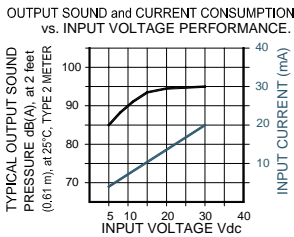

- Durable Stainless Steel 304 Diaphragm
- Epoxy Encapsulated Electronics
- UL Approved
- NEMA 4X Certified with Optional Gasket
- Reliable Piezoelectric Technology



The MC-V09-530-Q is a continuous tone, panel mounted alarm for operating voltages of 5-30VDC. The built-in volume control provides variable attenuation up to 20 dB(A) typically. The terminals are standard 0.25" quick-connect blades for push-on or direct solder attachment.

## SPECIFICATIONS

<b>Operating Mode:</b>	Medium Loud Continuous Tone
<b>Operating Voltage:</b>	5-30 Vdc
<b>Nominal Operating Voltage:</b>	30 Vdc
<b>Operating Frequency:</b>	2900±250 Hz.
<b>Typical Operating Current:</b>	2 mA at 5 Vdc 20 mA at 30 Vdc
<b>Typical Sound Pressure:</b>	With volume control fully open: 85±5 dB(A), at 5 Vdc, at 24 inches (61 cm), at 25°C 95±5 dB(A), at 30 Vdc, at 24 inches (61 cm), at 25°C.
<b>Termination:</b>	Quick Connect Blades, 0.25 (6.3) Width, 0.032 (0.8) Thickness
<b>Termination Strength:</b>	Pull test with a maximum of 22 pounds (10 kg) load
<b>Operating Temperature:</b>	-20°C to +65°C.
<b>Storage Temperature:</b>	-40°C to +85°C.
<b>Surge Voltage:</b>	20% over maximum rated voltage for less than 5 minutes.
<b>Reverse Voltage Protection:</b>	To the maximum operating voltage.
<b>Part Recognized By:</b>	Underwriters Laboratory
<b>Construction Materials:</b>	Case- Plastic "NORYL® N-190", Flame Retardant UL 94-VO, Black Internal Circuit- Audio-oscillator and piezoelectric driver Potting- 2 parts epoxy resin or silicone, black Diaphragm- Stainless Steel 304 Gasket (Sold Separately)- 0.062" Thick, 60 Durometer Neoprene
<b>Environmental Durability:</b>	Salt Spray- Withstand exposure to salt spray per ASTM B117 for a period of 300 hours with no decrease in sound output Humidity- 95% relative humidity at +40°C continuously for 100 hours. Vibration- Withstands vibration between 0 and 55 Hz. on all axes.
<b>Life Expectancy:</b>	10 years under normal operating conditions.
<b>Warranty:</b>	For a period of two years from the date of manufacture under normal operating conditions.

**RoHS** Also available RoHS Compliant — Add "R" to end of part number.

## DIMENSIONS

REAR VIEW

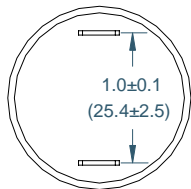

SIDE VIEW

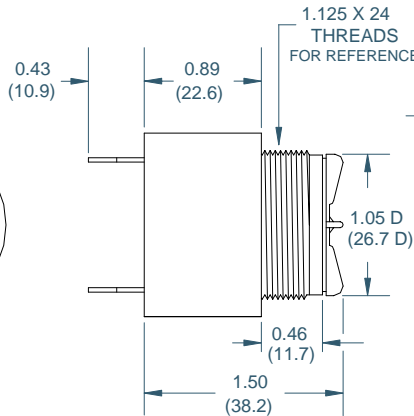

RING

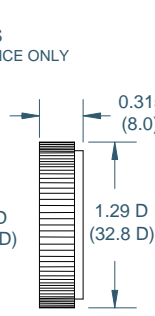

FRONT VIEW

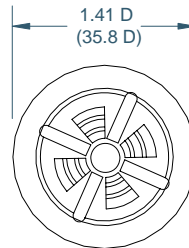

DIMENSIONS ARE IN: INCHES (mm)  
TOLERANCES ARE: ±0.03 (±0.76)  
UNLESS OTHERWISE SPECIFIED.

## PANEL MOUNTING

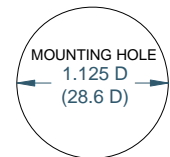

FITS PANELS UP-TO 0.25 (6.3) THICK

"Q" TERMINALS

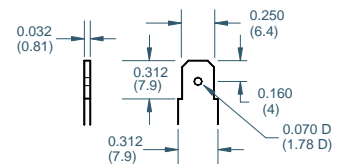

**Floyd Bell Inc**  
An ISO 9001:2000 Registered Company

720 Dearborn Park Lane • Columbus, OH 43085  
Tel: 888-FLOYD-BELL • Fax: 614/291-0823  
www.floydbell.com

Revision: 2.07