

MW-V09-301-Q

**Made in
USA**

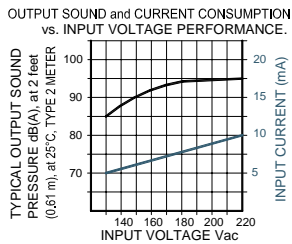

- Durable Stainless Steel 304 Diaphragm
- Epoxy Encapsulated Electronics
- UL Approved
- NEMA 4X Certified with Optional Gasket
- Reliable Piezoelectric Technology



The MW-V09-301-Q is a warble tone alarm with a typical loudness level of 95 dB (A). It can be operated over a voltage range of 130-220VAC and warbles at a rate of 15 times per second.

SPECIFICATIONS

Operating Mode: Medium Loud Warble Tone
Operating Voltage: 130-220 Vac
Nominal Operating Voltage: 220 Vac
Operating Frequency: High Frequency Peak: 2900±250 Hz.
 Low Frequency Peak: 2200±250 Hz.
 15±25% Cycles per second

Typical Operating Current: 5 mA at 130 Vac
 10 mA at 220 Vac

Typical Sound Pressure: With volume control fully open:
 85±5 dB(A), at 130 Vac, at 24 inches (61 cm), at 25°C
 95±5 dB(A), at 220 Vac, at 24 inches (61 cm), at 25°C.

Termination: Quick Connect Blades, 0.25 (6.3) Width, 0.032 (0.8) Thickness
Termination Strength: Pull test with a maximum of 22 pounds (10 kg) load
Operating Temperature: -20°C to +65°C.
Storage Temperature: -40°C to +85°C.
Surge Voltage: 20% over maximum rated voltage for less than 5 minutes.
Part Recognized By: Underwriters Laboratory
Construction Materials: Case- Plastic "NORYL® N-190", Flame Retardant UL 94-VO, Black Internal Circuit- Audio-oscillator and piezoelectric driver
 Potting- 2 parts epoxy resin or silicone, black
 Diaphragm- Stainless Steel 304
 Gasket (Sold Separately)- 0.062" Thick, 60 Durometer Neoprene

Environmental Durability: Salt Spray- Withstand exposure to salt spray per ASTM B117 for a period of 300 hours with no decrease in sound output
 Humidity- 95% relative humidity at +40°C continuously for 100 hours.
 Vibration- Withstands vibration between 0 and 55 Hz. on all axes.
 10 years under normal operating conditions.
 For a period of two years from the date of manufacture under normal operating conditions.

Life Expectancy: 10 years under normal operating conditions.
Warranty: For a period of two years from the date of manufacture under normal operating conditions.

RoHS Also available RoHS Compliant — Add "R" to end of part number.

DIMENSIONS

REAR VIEW

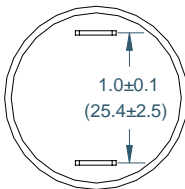

SIDE VIEW

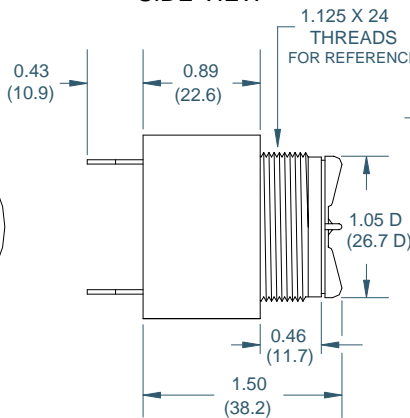

RING

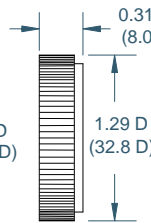

FRONT VIEW

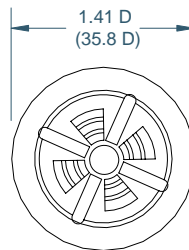

DIMENSIONS ARE IN: INCHES (mm)
 TOLERANCES ARE: ±0.03 (±0.76)
 UNLESS OTHERWISE SPECIFIED.

PANEL MOUNTING

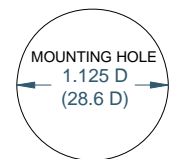

FITS PANELS UP-TO 0.25 (6.3) THICK

"Q" TERMINALS

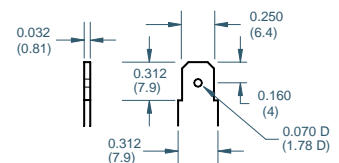

Floyd Bell Inc
 An ISO 9001:2000 Registered Company

720 Dearborn Park Lane • Columbus, OH 43085
 Tel: 888-FLOYD-BELL • Fax: 614/291-0823
 www.floydbell.com

Revision: 2.07