

XC-09-212-Q

**Made in
USA**

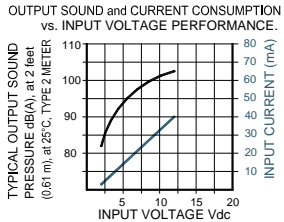

- Durable Stainless Steel 304 Diaphragm
- Epoxy Encapsulated Electronics
- UL Approved
- NEMA 4X Certified with Optional Gasket
- Reliable Piezoelectric Technology



The XC-09-212-Q is an extra loud output, panel mounted alarm for operating voltages of 2-12VDC. The continuous tone has a typical sound pressure level of 103 dB(A) at maximum voltage. The terminals are standard 0.25" quick-connect blades for push-on or direct solder attachment.

SPECIFICATIONS

Operating Mode:	Extra Loud Continuous Tone
Operating Voltage:	2-12 Vdc
Nominal Operating Voltage:	12 Vdc
Operating Frequency:	2900±500 Hz.
Typical Operating Current:	3 mA at 2 Vdc 40 mA at 12 Vdc
Typical Sound Pressure:	82±5 dB(A), at 2 Vdc, at 24 inches (61 cm), at 25°C 103±5 dB(A), at 12 Vdc, at 24 inches (61 cm), at 25°C.
Termination:	Quick Connect Blades, 0.25 (6.3) Width, 0.032 (0.8) Thickness
Termination Strength:	Pull test with a maximum of 22 pounds (10 kg) load
Operating Temperature:	-20°C to +65°C.
Storage Temperature:	-40°C to +85°C.
Surge Voltage:	20% over maximum rated voltage for less than 5 minutes.
Part Recognized By:	Underwriters Laboratory
Reverse Voltage Protection:	To the maximum operating voltage.
Construction Materials:	Case- Plastic "NORYL® N-190", Flame Retardant UL 94-VO, Black Internal Circuit- Audio-oscillator and piezoelectric driver Potting- 2 parts epoxy resin or silicone, black Diaphragm- Stainless Steel 304 Gasket (Sold Separately)- 0.062" Thick, 60 Durometer Neoprene
Environmental Durability:	Salt Spray- Withstand exposure to salt spray per ASTM B117 for a period of 300 hours with no decrease in sound output Humidity- 95% relative humidity at +40°C continuously for 100 hours. Vibration- Withstands vibration between 0 and 55 Hz. on all axes.
Life Expectancy:	10 years under normal operating conditions.
Warranty:	For a period of two years from the date of manufacture under normal operating conditions.

RoHS Also available RoHS Compliant — Add "R" to end of part number.

DIMENSIONS

PANEL MOUNTING

REAR VIEW

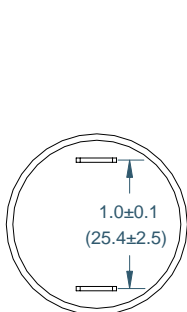

SIDE VIEW

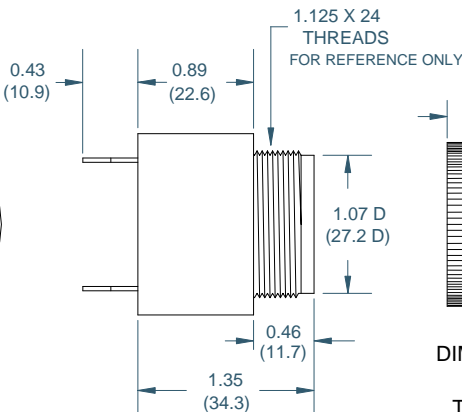

RING

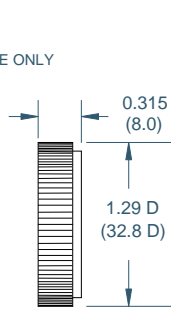

FRONT VIEW

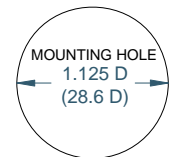
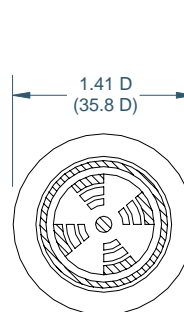

FITS PANELS UP-TO
0.25 (6.3) THICK

"Q" TERMINALS

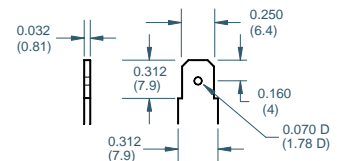

DIMENSIONS ARE IN: INCHES (mm)
TOLERANCES ARE: ±0.03 (±0.76)
UNLESS OTHERWISE SPECIFIED.

Floyd Bell Inc
An ISO 9001:2000 Registered Company

720 Dearborn Park Lane • Columbus, OH 43085
Tel: 888-FLOYD-BELL • Fax: 614/291-0823
www.floydbell.com

Revision: 2.07