

[AudioLarm II Series](#)  
MC-07-116-Q



## Dimensions



More Information

 [UL Recognized](#)

 **RoHS** Compliant

## Specifications

<b>Mounting</b>	Panel Mount
<b>Operating Mode</b>	Medium Loud Continuous Tone
<b>Operating Voltage</b>	3-16 Vdc
<b>Operating Frequency</b>	2900±250 Hz
<b>Typical Operating Current</b>	3 mA at 3 Vdc 20 mA at 16 Vdc
<b>Typical Sound Pressure</b>	68 ±5 dB(A) at 3 Vdc at 24 inches (61 cm), at 25°C 93 ±5 dB(A) at 16 Vdc at 24 inches (61 cm), at 25°C
<b>Termination</b>	Quick Connect Blades
<b>Termination Strength</b>	Pull test with a maximum of 22 pounds (10 kg) load
<b>Operating Temperature</b>	-20_C to +65_C
<b>Storage Temperature</b>	-40_C to +85_C
<b>Surge Voltage</b>	20% over maximum rated voltage for less than 5 minutes
<b>Reverse Voltage Protection</b>	To the maximum operating voltage
<b>Construction Materials</b>	Case- Plastic _NORYL_ N-190, Flame Retardant UL 94-VO, Black Internal Circuit- Audio-oscillator and piezoelectric driver Potting- 2 parts epoxy resin or silicone, black Diaphragm- Stainless Steel 304
<b>Gasket</b>	Gasket (sold separately) 0.062" thick, 60 Durometer Neoprene ASTM B117 Certified - Withstands exposure to salt spray for 300 hours IP 68 Certified - Withstands water submergence and dust exposure
<b>Construction Materials</b>	Humidity- 95% relative humidity at +40_C continuously for 100 hours. Vibration- Withstands vibration between 0 and 55 Hz. on all axes.
<b>Life Expectancy</b>	10 years under normal operating conditions.
<b>Warranty</b>	For a period of two years from the date of manufacture under normal operating conditions.

**Notes**

This product is not intended as a life safety device.

**Terms and Conditions of Sale** [Link here](#)

**REAR**

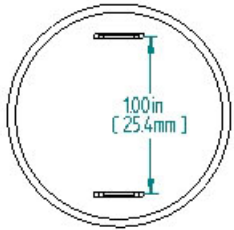

TOLERANCES ARE:  $\pm 0.03$  in.  
[ $\pm 0.76$  mm]

**SIDE**

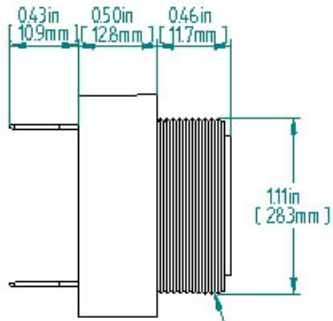

1.125-24 UNF THREADS  
FOR REFERENCE ONLY

**RING**

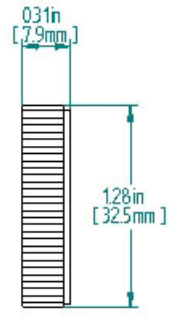

**FRONT**

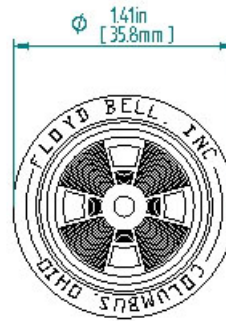

**PANEL MOUNTING**



FITS PANELS UP TO  
0.25 in [6.35 mm] THICK

**"Q" TERMINALS**

