

[AudioLarm II Series](#)

MB-V09-201-Q(M)

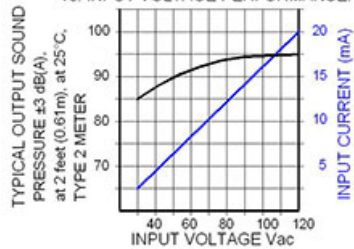

OUTPUT SOUND and CURRENT CONSUMPTION vs. INPUT VOLTAGE PERFORMANCE.



More Information

 [UL Recognized](#)

 [RoHS Compliant](#)

**Specifications**

<b>Mounting</b>	Panel Mount with Volume Control
<b>Operating Mode</b>	Medium Loud Medium Beep Tone
<b>Operating Voltage</b>	30-120 Vac
<b>Operating Frequency</b>	2900±250 Hz
<b>Typical Operating Current</b>	5 mA at 30 Vac 20 mA at 120 Vac
<b>Typical Sound Pressure</b>	85 ±5 dB(A) at 30 Vac at 24 inches (61 cm), at 25°C 95 ±5 dB(A) at 120 Vac at 24 inches (61 cm), at 25°C
<b>Termination</b>	Quick Connect Blades
<b>Termination Strength</b>	Pull test with a maximum of 22 pounds (10 kg) load
<b>Operating Temperature</b>	-20_C to +65_C
<b>Storage Temperature</b>	-40_C to +85_C
<b>Surge Voltage</b>	20% over maximum rated voltage for less than 5 minutes
<b>Reverse Voltage Protection</b>	To the maximum operating voltage
<b>Construction Materials</b>	Case- Plastic _NORYL_ N-190, Flame Retardant UL 94-VO, Black Internal Circuit- Audio-oscillator and piezoelectric driver Potting- 2 parts epoxy resin or silicone, black Diaphragm- Stainless Steel 304
<b>Gasket</b>	Gasket (sold separately) 0.062" thick, 60 Durometer Neoprene ASTM B117 Certified - Withstands exposure to salt spray for 300 hours IP 68 Certified - Withstands water submergence and dust exposure Humidity- 95% relative humidity at +40_C continuously for 100 hours. Vibration- Withstands vibration between 0 and 55 Hz. on all axes.
<b>Construction Materials</b>	
<b>Life Expectancy</b>	10 years under normal operating conditions.
<b>Warranty</b>	For a period of two years from the date of manufacture under normal operating conditions.
<b>Notes</b>	This product is not intended as a life safety device.
<b>Terms and Conditions of Sale</b>	<a href="#">Link here</a>

□

Dimensions

REAR

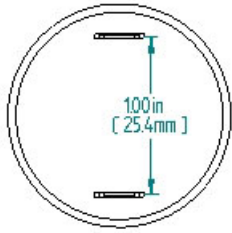

TOLERANCES ARE:  $\pm 0.03$  in.  
[ $\pm 0.76$  mm]

SIDE

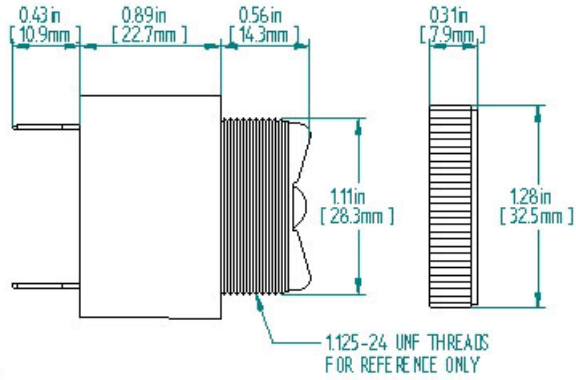

RING

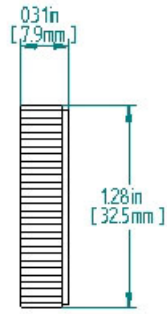

FRONT

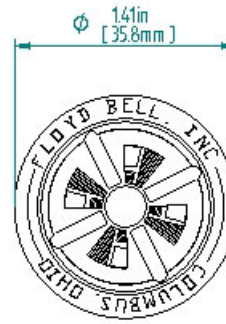

PANEL MOUNTING



FITS PANELS UP TO  
0.25 in [6.35mm] THICK

"Q" TERMINALS

