

[AudioLarm II Series](#)
MC-07-116-Q



Dimensions



More Information

 [UL Recognized](#)

 **RoHS** Rohs Compliant

Specifications

Mounting	Panel Mount
Operating Mode	Medium Loud Continuous Tone
Operating Voltage	3-16 Vdc
Operating Frequency	2900±250 Hz
Typical Operating Current	3 mA at 3 Vdc 20 mA at 16 Vdc
Typical Sound Pressure	68 ±5 dB(A) at 3 Vdc at 24 inches (61 cm), at 25°C 93 ±5 dB(A) at 16 Vdc at 24 inches (61 cm), at 25°C
Termination	Quick Connect Blades
Termination Strength	Pull test with a maximum of 22 pounds (10 kg) load
Operating Temperature	-20_C to +65_C
Storage Temperature	-40_C to +85_C
Surge Voltage	20% over maximum rated voltage for less than 5 minutes
Reverse Voltage Protection	To the maximum operating voltage
Construction Materials	Case- Plastic _NORYL_ N-190, Flame Retardant UL 94-VO, Black Internal Circuit- Audio-oscillator and piezoelectric driver Potting- 2 parts epoxy resin or silicone, black Diaphragm- Stainless Steel 304
Gasket	Gasket (sold separately) 0.062" thick, 60 Durometer Neoprene ASTM B117 Certified - Withstands exposure to salt spray for 300 hours IP 68 Certified - Withstands water submergence and dust exposure
Construction Materials	Humidity- 95% relative humidity at +40_C continuously for 100 hours. Vibration- Withstands vibration between 0 and 55 Hz. on all axes.
Life Expectancy	10 years under normal operating conditions.
Warranty	For a period of two years from the date of manufacture under normal operating conditions.

Notes

This product is not intended as a life safety device.

Terms and Conditions of Sale [Link here](#)

REAR

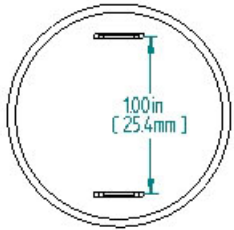

TOLERANCES ARE: ± 0.03 in.
[± 0.76 mm]

SIDE

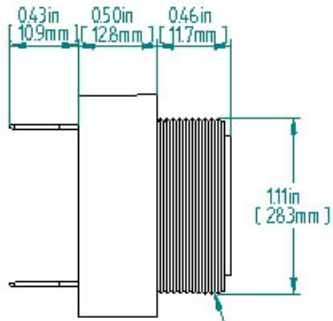

1.125-24 UNF THREADS
FOR REFERENCE ONLY

RING

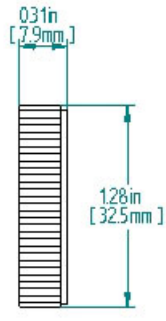

FRONT

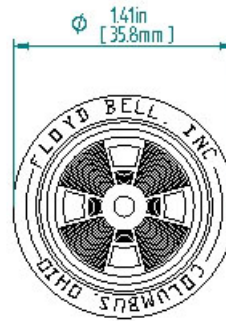

PANEL MOUNTING



FITS PANELS UP TO
0.25 in [6.35 mm] THICK

"Q" TERMINALS

